

ART 712-A MK4

ACTIVE TWO-WAY SPEAKER

DESCRIPTION

ART 712-A MK4 is a unique product in its category. The professional compression driver with custom designed dome and high power voice coil offers unique vocal clarity and sound projection. The 12" woofer offers an extremely linear response and a precise, deep low frequency control. The transducers are produced using the most advanced assembly technologies. The amplifier delivers 1400 watts and is controlled by a DSP that takes care of crossover, equalisation, phase control, soft limiting and speaker protections.



FEATURES

- 129 dB Max SPL
- 1400 WATT 2-way peak power
- Innovative DSP Processing
- 1" Compression Driver, 1.75" v.c.
- 12" Woofer
- 90°x60°, wide dispersion constant directivity horn
- FiRPHASE Technology

TECHNICAL SPECIFICATIONS

Acoustical specifications	Frequency Response:	50 Hz ÷ 20000 Hz
	Max SPL @ 1m:	129 dB
	Horizontal coverage angle:	90°
	Vertical coverage angle:	60°
Transducers	Compression Driver:	1 x 1.0", 1.75" v.c
	Woofers:	12", 2.5" v.c
Input/Output section	Input signal:	bal/unbal
	Input connectors:	XLR, Jack
	Output connectors:	XLR
	Input sensitivity:	-2 dBu/+4 dBu
	Mic. Input Sensitivity:	-32 dBu
Processor section	Crossover Frequencies:	1600 Hz
	Protections:	Thermal, RMS
	Limiter:	Soft Limiter
	Controls:	Volume, Boost, Mic/Line
Power section	Total Power:	1400 W Peak, 700 W RMS
	High frequencies:	400 W Peak, 200 W RMS
	Low frequencies:	1000 W Peak, 500 W RMS
	Cooling:	Convection
	Connections:	VDE
Standard compliance	Safety agency:	CE compliant
Physical specifications	Cabinet/Case Material:	PP Composite
	Hardware:	2 x M10
	Handles:	1 Top, 2 Side
	Pole mount/Cap:	Yes
	Grille:	Steel
	Color:	Black
Size	Height:	637 mm / 25.08 inches
	Width:	387 mm / 15.24 inches
	Depth:	363 mm / 14.29 inches
	Weight:	17.8 kg / 39.24 lbs
Shipping information	Package Height:	680 mm / 26.77 inches
	Package Width:	440 mm / 17.32 inches
	Package Depth:	420 mm / 16.54 inches
	Package Weight:	20.6 kg / 45.42 lbs



PART NUMBER

• **13000523**

ART 712-A MK4

115V

EAN 8024530014919

• **13000522**

ART 712-A MK4

220-240V

EAN 8024530014735

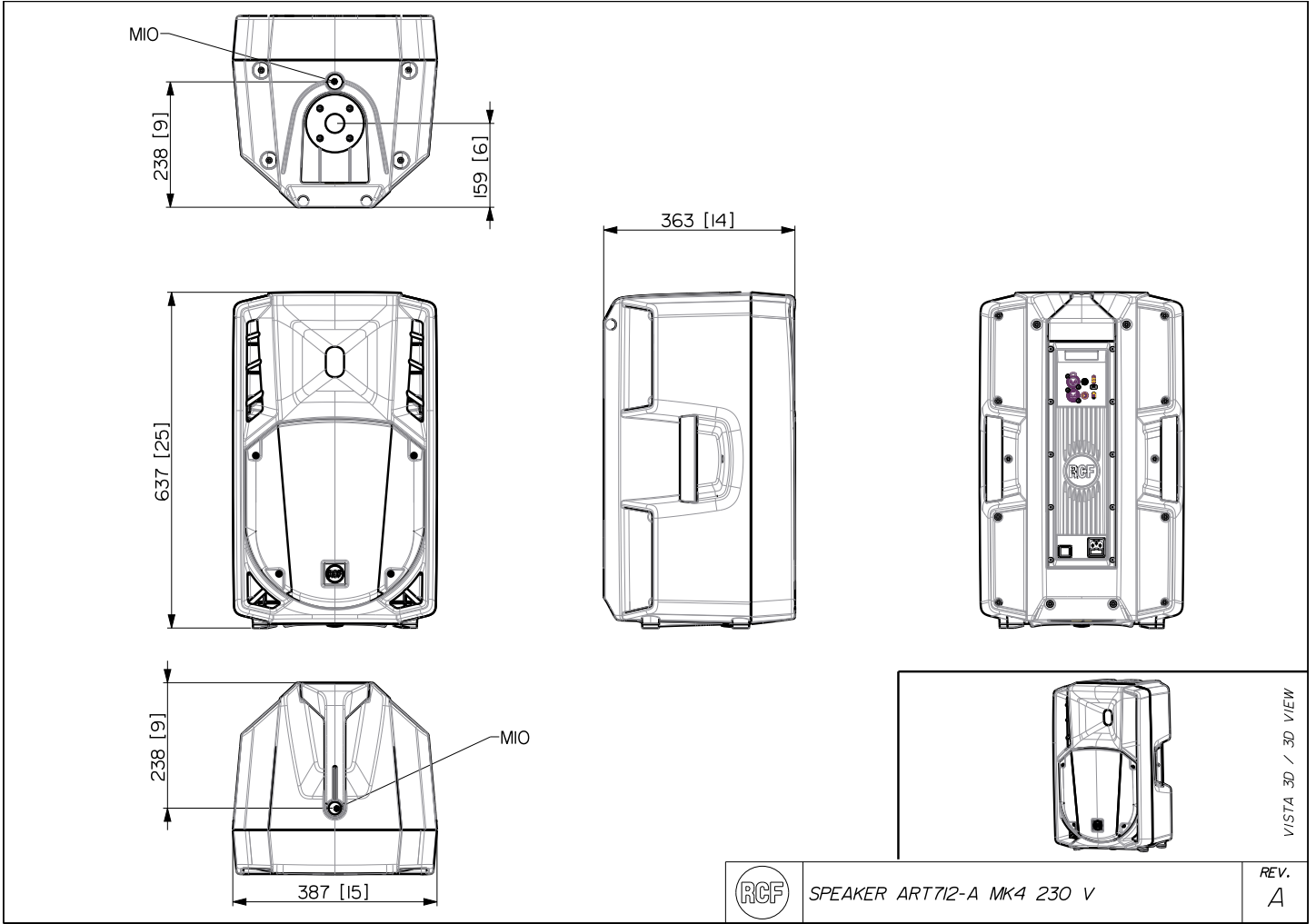

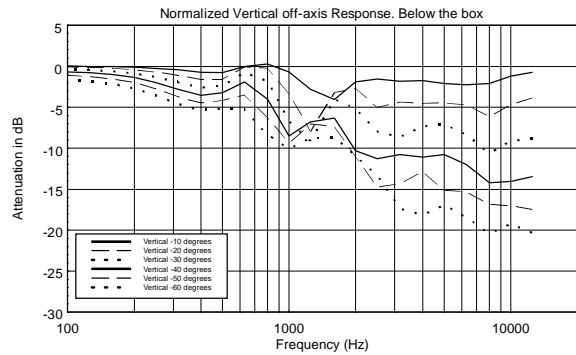
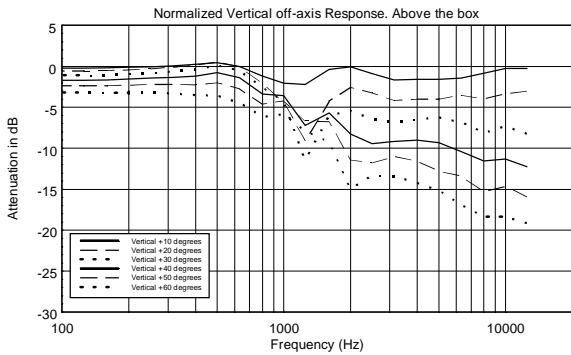
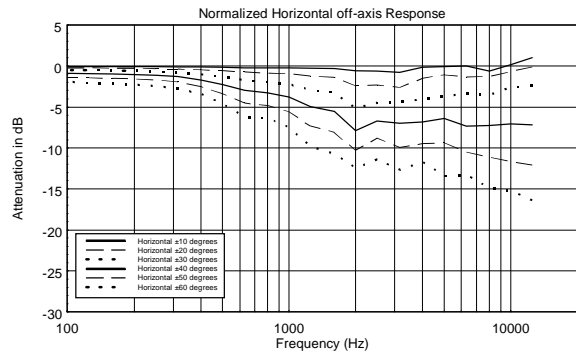
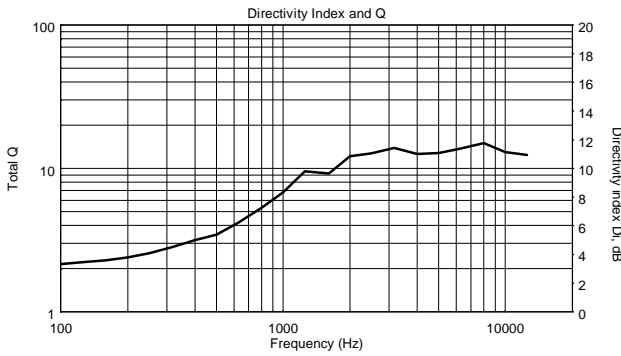
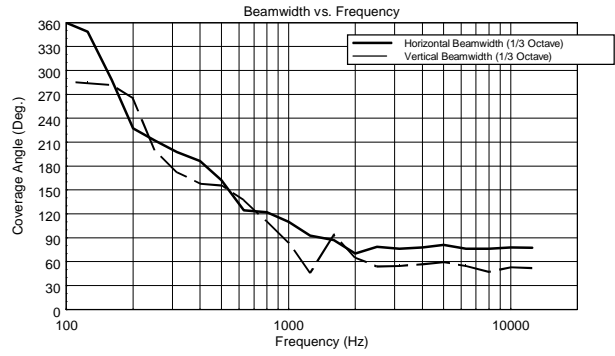
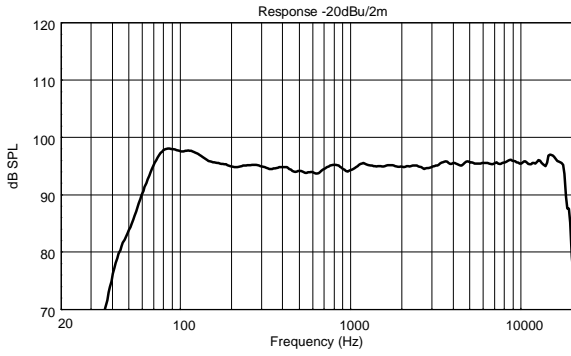

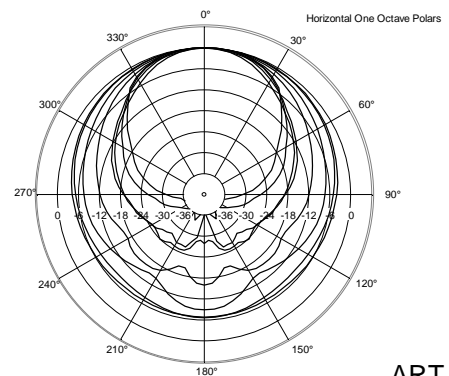
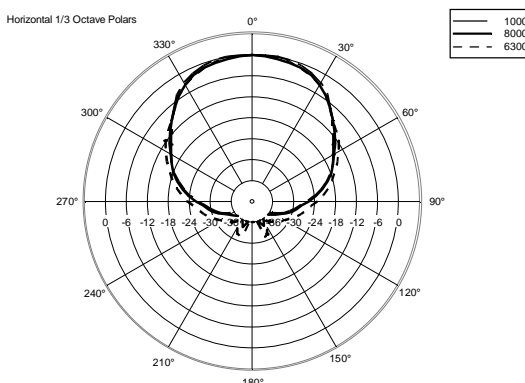
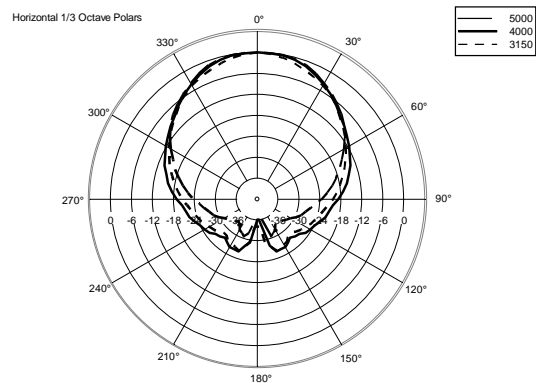
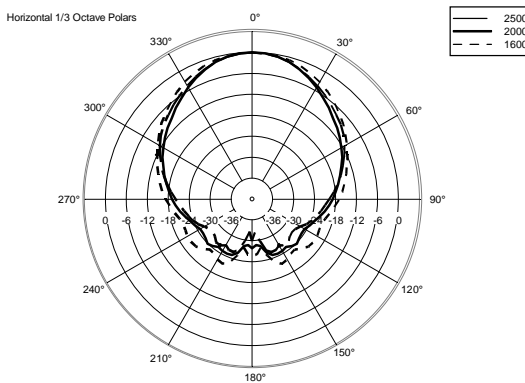
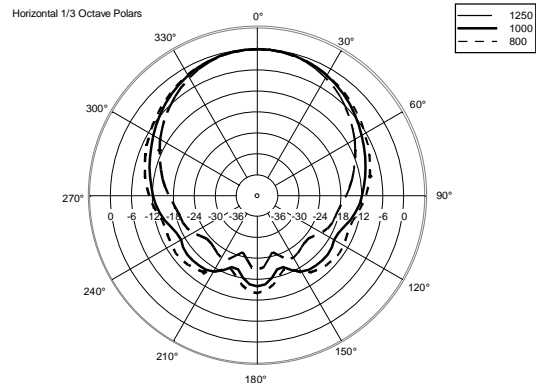
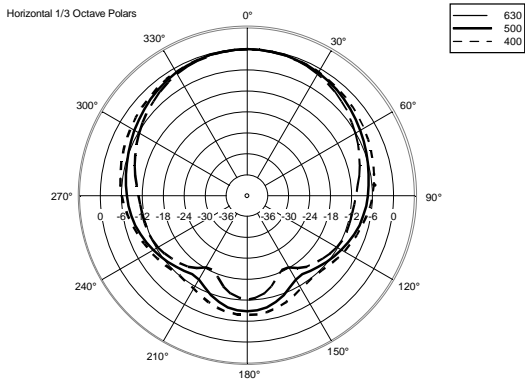
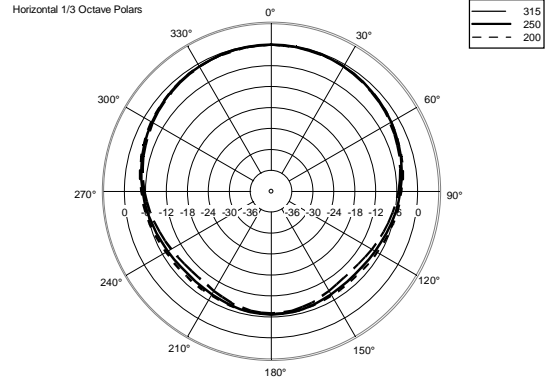
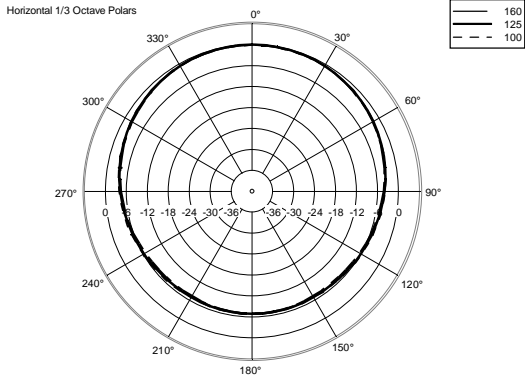

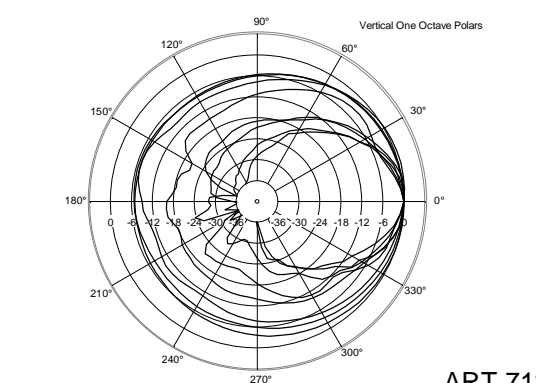
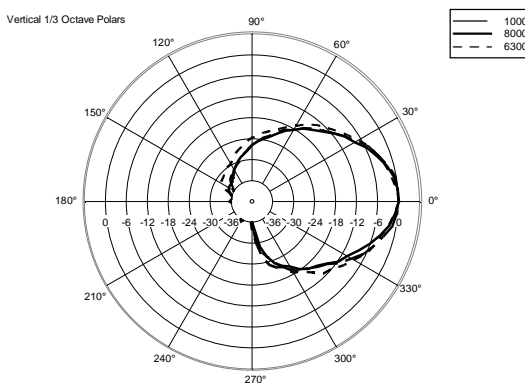
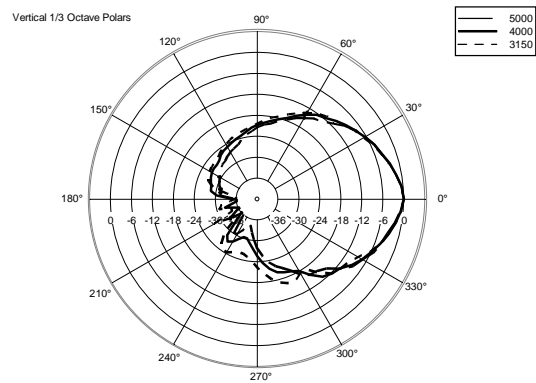
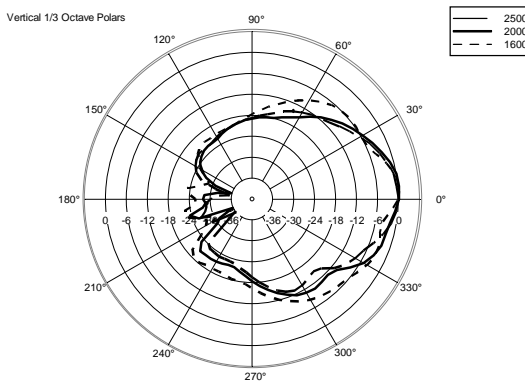
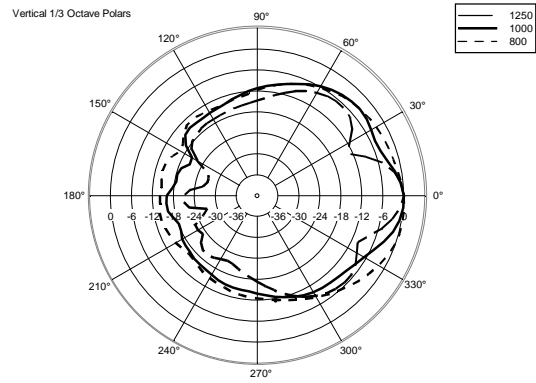
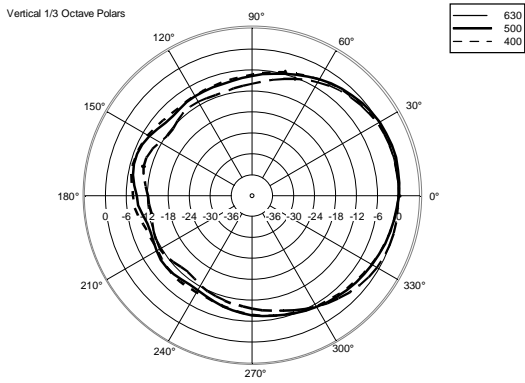
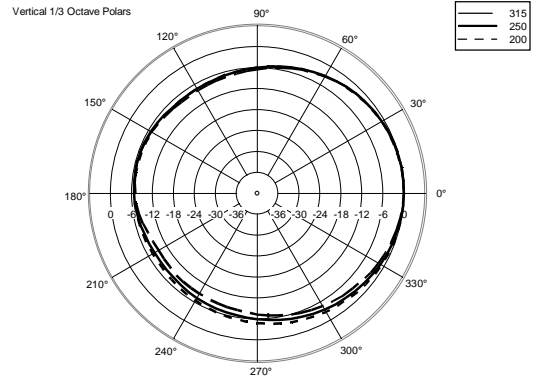
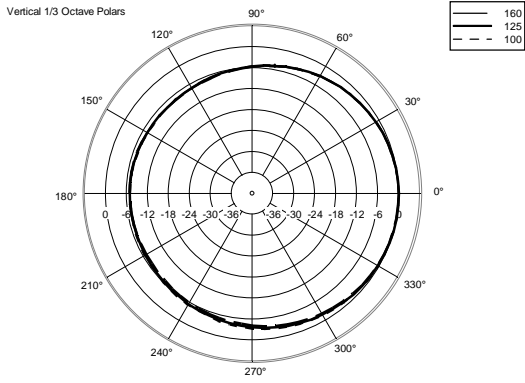

ACCESSORIES

AC PM-M20

PART NUMBER **13360067**
EAN: 8024530014599

AC PMX POLE MOUNT M20

PART NUMBER **13360232**
EAN: 8024530010058

AC PRO-FS PROFESS. LOCKING FLOOR STAND

PART NUMBER **13360109**
EAN: 8024530006471

AC PRO-PM PROFESS. LOCKING POLE MOUNT

PART NUMBER **13360110**
EAN: 8024530006488

COVER CVR ART 722

PART NUMBER **13360114**
EAN: 8024530010669

HORIZONTAL BRACKET H-BR 2X ART 712

PART NUMBER **13360104**
EAN: 8024530015855