

ROGUE



User Manual



Model ID: ROGUEOUTCAST2XWASH

Edition Notes

The Rogue Outcast 2X Wash User Manual includes a description, safety precautions, installation, programming, operation and maintenance instructions for the Rogue Outcast 2X Wash as of the release date of this edition.

Trademarks

Chauvet, Chauvet Professional, the Chauvet logo, Rogue, Outcast, and Rogue Outcast are registered trademarks or trademarks of Chauvet & Sons, LLC (d/b/a Chauvet and Chauvet Lighting) in the United States and other countries. Other company and product names and logos referred to herein may be trademarks of their respective companies.

Copyright Notice

The works of authorship contained in this manual, including, but not limited to, all design, text and images are owned by Chauvet.

© **Copyright 2023 Chauvet & Sons, LLC. All rights reserved.**

Electronically published by Chauvet in the United States of America.

Manual Use

Chauvet authorizes its customers to download and print this manual for professional information purposes only. Chauvet expressly prohibits the usage, copy, storage, distribution, modification, or printing of this manual or its content for any other purpose without written consent from Chauvet.

Document Printing

For best results, print this document in color, on letter size paper (8.5 x 11 in), double-sided. If using A4 paper (210 x 297 mm), configure the printer to scale the content accordingly.

Intended Audience

Any person installing, operating, and/or maintaining this product should completely read through the guide that shipped with the product, as well as this manual, before installing, operating, or maintaining this product.

Disclaimer

Chauvet believes that the information contained in this manual is accurate in all respects. However, Chauvet assumes no responsibility and specifically disclaims any and all liability to any party for any loss, damage or disruption caused by any errors or omissions in this document, whether such errors or omissions result from negligence, accident or any other cause. Chauvet reserves the right to revise the content of this document without any obligation to notify any person or company of such revision, however, Chauvet has no obligation to make, and does not commit to make, any such revisions. Download the latest version from www.chauvetprofessional.com.

Document Revision

This Rogue Outcast 2X Wash User Manual is the 3rd edition of this document. Go to www.chauvetprofessional.com for the latest version.

TABLE OF CONTENTS

1. Before You Begin 1
What Is Included 1
Claims 1
Text Conventions 1
Symbols 1
FCC Compliance..... 1
Expected LED Lifespan..... 1
Safety Notes..... 2
2. Introduction 3
Description 3
Features 3
Product Overview..... 3
Product Dimensions 4
3. Setup 5
AC Power 5
AC Plug 5
Power Linking..... 5
Fuse Replacement..... 5
DMX Linking..... 5
Remote Device Management (RDM) 5
USB Software Update 5
Mounting 6
Orientation..... 6
Rigging 6
Procedure..... 6
4. Operation 7
Control Panel Description 7
Menu Map 7
Configuration (DMX) 9
Control Personalities 9
Starting Address..... 9
Control Channel Assignments and Values..... 10
Zones for DMX Control 10
Strobe Chart..... 10
Color Chart..... 10
Zone Selection Chart 11
Programs Chart..... 11
Control Chart..... 11
Advanced Modes 12
Basic Modes..... 13
MS Modes 14
Configuration (Settings) 15
Pan Reverse 15
Tilt Reverse 15
Pan Angle..... 15
Tilt Angle 15
Fan Mode 15
Display Backlight Timer..... 15
Screen Reverse 16
Dimmer Curve 16

Dimmer Speed	16
Pulse Width Modulation	16
LED Power	16
White Mode	16
Color Calibration	16
USB Update	16
Reset Function	17
Factory Reset.....	17
Test Mode	17
Auto Test.....	17
Manual Test	17
System Information	17
Offset Mode (Zero Adjust).....	17
5. Maintenance.....	18
Product Maintenance	18
Torque Measurements	18
Vacuum Test Measurements	18
6. Technical Specifications	19
Contact Us	20
Warranty & Returns.....	20

Before You Begin

1. Before You Begin

What Is Included

- Rogue Outcast 2X Wash
- Seetronic Powerkon IP65 power cable
- 2 Omega brackets with mounting hardware
- Quick Reference Guide

Claims

Carefully unpack the product immediately and check the container to make sure all the parts are in the package and are in good condition.



If the box or the contents (the product and included accessories) appear damaged from shipping, or show signs of mishandling, notify the carrier immediately, not Chauvet. Failure to report damage to the carrier immediately may invalidate the claim. In addition, keep the box and contents for inspection.

For other issues, such as missing components or parts, damage not related to shipping, or concealed damage, file a claim with Chauvet within 7 days of delivery.

Text Conventions

Convention	Meaning
1–512	A range of values
50/60	A set of values of which only one can be chosen
Settings	A menu option not to be modified
<ENTER>	A key to be pressed on the product's control panel

Symbols

Symbol	Meaning
	Critical installation, configuration, or operation information. Not following these instructions may make the product not work, cause damage to the product, or cause harm to the operator.
	Important installation or configuration information. The product may not function correctly if this information is not used.
	Useful information.



Any reference to data or power connections in this manual assumes the use of Seetronic IP rated cables.



The term “DMX” used throughout this manual refers to the USITT DMX512-A digital data transmission protocol.

FCC Compliance

This device complies with Part 15 Part B of the FCC Rules. Operation is subject to the following two conditions:

1. This device may not cause harmful interference, and
2. This device must accept any interference received, including interference that may cause undesired operation.

Any changes or modifications not expressly approved by the party responsible for compliance could void the user's authority to operate the equipment.

Expected LED Lifespan

Over time, use and heat will gradually reduce LED brightness. Clustered LEDs produce more heat than single LEDs, contributing to shorter lifespans if always used at full intensity. The average LED lifespan is 40,000 to 50,000 hours. To extend LED lifespan, maintain proper ventilation around the product, and limit the overall intensity.

Safety Notes

These Safety Notes include important information about installation, use, and maintenance.

- The luminaire should be positioned so that prolonged staring into the luminaire at a distance closer than 21 ft (6.5 m) is not expected.
- If the external flexible cable or cord of this luminaire is damaged, it shall be replaced by a special cord or cord exclusively available from the manufacturer or his service agent.
- The light source contained in this luminaire shall only be replaced by the manufacturer or his service agent or a similar qualified person.
- The luminaire is intended for professional use only.
- DO NOT open this product. It contains no user-serviceable parts.
- To eliminate unnecessary wear and improve its lifespan, during periods of non-use completely disconnect the product from power via breaker or by unplugging it.
- DO NOT look at the light source when the product is on.
- CAUTION: This product's housing may be hot when lights are operating. Mount this product in a location with adequate ventilation, at least 20 in (50 cm) from adjacent surfaces.
- DO NOT leave any flammable material within 20 cm of this product while operating or connected to power.
- CAUTION: When transferring product from extreme temperature environments, (e.g., cold truck to warm humid ballroom) condensation may form on the internal electronics of the product. To avoid causing a failure, allow product to fully acclimate to the surrounding environment before connecting it to power.
- USE a safety cable when mounting this product overhead.
- DO NOT submerge this product (IP65). Regular outdoor operation is fine.
- Not for permanent outdoor installation in locations with extreme environmental conditions.
- DO NOT operate this product if the housing, lenses, or cables appear damaged.
- DO NOT connect this product to a dimmer or rheostat.
- ONLY connect this product to a grounded and protected circuit.
- ONLY use the hanging/mounting bracket to carry this product.
- In the event of a serious operating problem, stop using immediately.
- The maximum ambient temperature is 113 °F (45 °C). Do not operate this product at higher temperatures.
- The minimum startup temperature is -4°F (-20°C). Do not start the product at lower temperatures.
- The minimum ambient temperature is -22°F (-30°C). Do not operate the product at lower temperatures.

2. Introduction

Description

The Rogue Outcast 2X Wash is an IP65 moving head that outputs a bright, powerful light and offers five zones of LED control for pixel mapping. The outdoor-ready unit features a durable, lightweight aluminum/magnesium alloy body and a standout zoom range of 8° to 66.1°, giving it the spread to cover even the largest areas. Control is over DMX and RDM.

Features

- Fully featured IP65 RGBW LED yoke wash fixture with LED zone control, zoom, durable and lightweight aluminum/magnesium alloy body.
- 16-bit dimming of master dimmer as well as individual colors for smooth control of fades
- 19 RGBW LEDs, 25 W each
- 5-pin DMX input/output connections
- 5 zones of LED control for pixel mapping control
- Fast, smooth pan and tilt movement
- RDM enabled for remote addressing and trouble shooting
- Selectable PWM options for camera operation
- Easy to read OLED display with simple, effective menu options
- User selectable calibrated white for 7500 K at full output
- 6 distinct dimming modes for advanced control
- Easy to read OLED display with simple, effective menu options
- Simple and complex DMX channel profiles for programming versatility
- USB-C port for uploading software

Product Overview

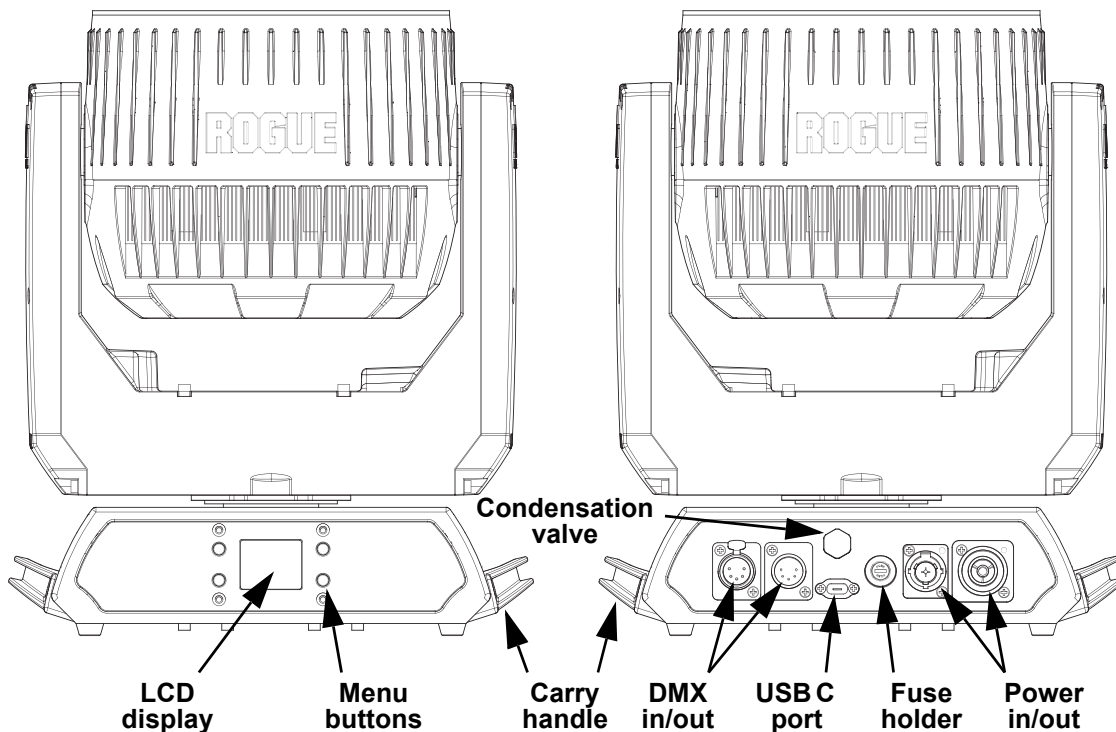

Product Dimensions

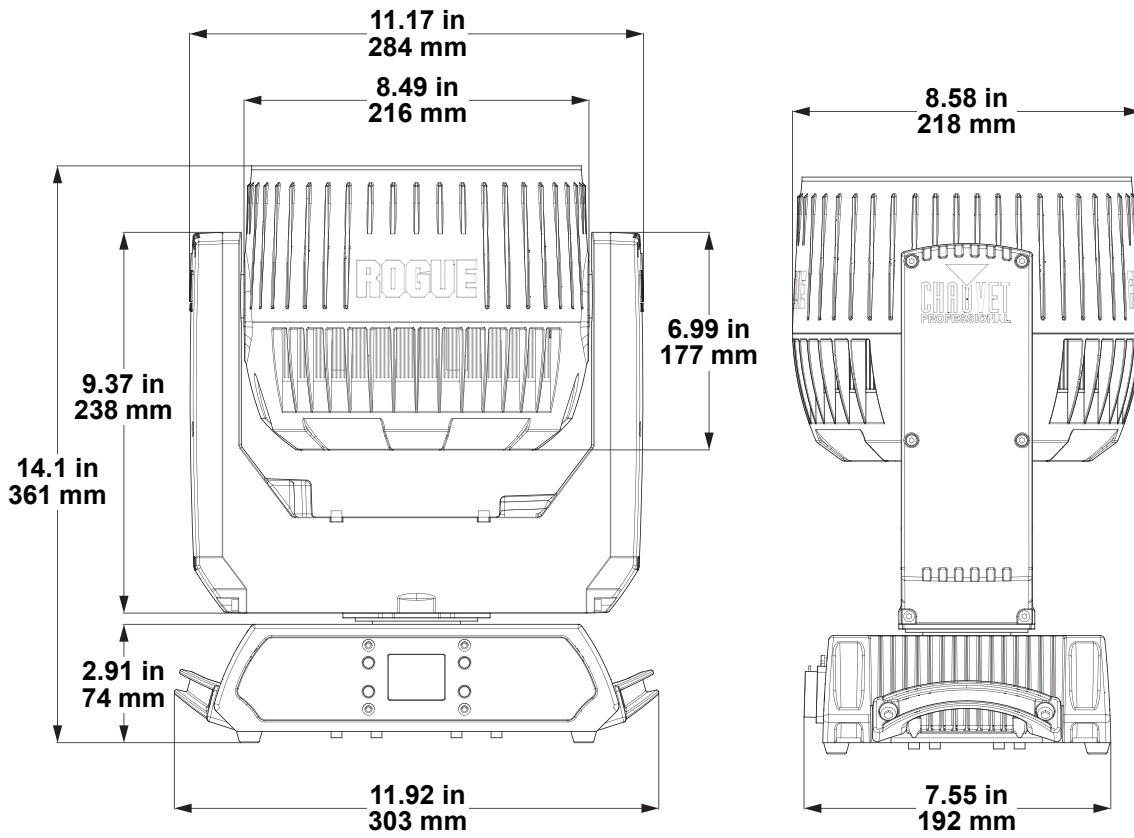

3. Setup

AC Power

The Rogue Outcast 2X Wash has an auto-ranging power supply and it can work with an input voltage range of 100 to 240 VAC, 50/60 Hz.

To determine the product's power requirements (circuit breaker, power outlet, and wiring), use the current value listed on the label affixed to the product's back panel, or refer to the product's specifications chart. The listed current rating indicates the product's average current draw under normal conditions.



- **Always connect the product to a protected circuit (a circuit breaker or fuse). Make sure the product has an appropriate electrical ground to avoid the risk of electrocution or fire.**
- **To eliminate unnecessary wear and improve its lifespan, during periods of non-use completely disconnect the product from power via breaker or by unplugging it.**



- **Never connect the product to a rheostat (variable resistor) or dimmer circuit, even if the rheostat or dimmer channel serves only as a 0 to 100% switch.**

AC Plug

The Rogue Outcast 2X Wash comes with a power input cable terminated with a Seetronic Powerkon A connector on one end and bare wire on the other end (U.S. market). Use the table below to wire a plug.

Connection	Wire (U.S.)	Wire (Europe)	Screw Color
AC Live	Black	Brown	Yellow or Brass
AC Neutral	White	Blue	Silver
AC Ground	Green/Yellow	Green/Yellow	Green

Power Linking

The product supports power linking. It is possible to power link up to 4 Rogue Outcast 2X Wash products at 100 V, 5 products at 120 V, 9 products at 208 V, 10 products at 230 V, or up to 11 products at 240 V. Never exceed this number. This product comes with a power input cable. Power linking cables are available from Chauvet for purchase.

Fuse Replacement

1. Disconnect this product from the power outlet.
2. Using a flat-head screwdriver, unscrew the fuse holder cap from the housing.
3. Remove the blown fuse and replace with another fuse of the same type and rating (8 A, 250 V).
4. Screw the fuse holder cap back in place and reconnect power.

DMX Linking

The Rogue Outcast 2X Wash will work with a DMX controller using a 5-pin DMX serial connection. A DMX Primer is available from www.chauvetprofessional.com.

Remote Device Management (RDM)

Remote Device Management, or RDM, is a standard for allowing DMX-enabled devices to communicate bi-directionally along existing DMX cabling. Check the DMX controller's User Manual or with the manufacturer as not all DMX controllers have this capability. The Rogue Outcast 2X Wash supports RDM protocol that allows feedback to make changes to menu map options.

USB Software Update

The Rogue Outcast 2X Wash allows for software update through USB using the built-in USB port. The product's USB port supports up to 32GB capacity and only works with FAT32 file format. To update the software using a USB flash drive, do the following:

1. Power on the product and plug the flash drive into the USB port.
2. Once the flash drive has been detected, the message "Upgrade Firmware" will be displayed. Press **<ENTER>**. If a different message appears on the display, search for the updated software in the **Menu (Updated Firmware)**. A list of the updated software files will be displayed.
3. Select the file that needs to be uploaded. The message "Are you sure?" will be displayed. Press **<ENTER>**.
4. If the selected file is correct, the update will be completed. Restart the product. If the selected file is incorrect, the update will fail, and the display will go back to the main interface. Repeat steps 1–3 using the correct file.

Mounting

Before mounting the product, read and follow the safety recommendations indicated in the Safety Notes. For our CHAUVET Professional line of mounting clamps, go to <http://trusst.com/products/>.

Orientation

Always mount this product in a safe position, making sure there is adequate room for ventilation, configuration, and maintenance.

Rigging

Chauvet recommends using the following general guidelines when mounting this product.

- Before deciding on a location for the product, make sure there is easy access to the product for maintenance and programming purposes.
- Make sure that the structure onto which the product is being mounted can support the product's weight. See the [Technical Specifications](#) for weight information.
- When mounting the product overhead, always use a safety cable. Mount the product securely to a rigging point, whether an elevated platform or a truss.
- When rigging the product onto a truss, use a mounting clamp of appropriate weight capacity.

Procedure

The Rogue Outcast 2X Wash comes with 2 omega brackets which can be directly attach to mounting clamps (sold separately). Make sure the clamps are capable of supporting the weight of this product. Use at least two mounting points per product. For the CHAUVET Professional line of mounting clamps, go to <http://www.trusst.com/products>.

Mounting Diagram

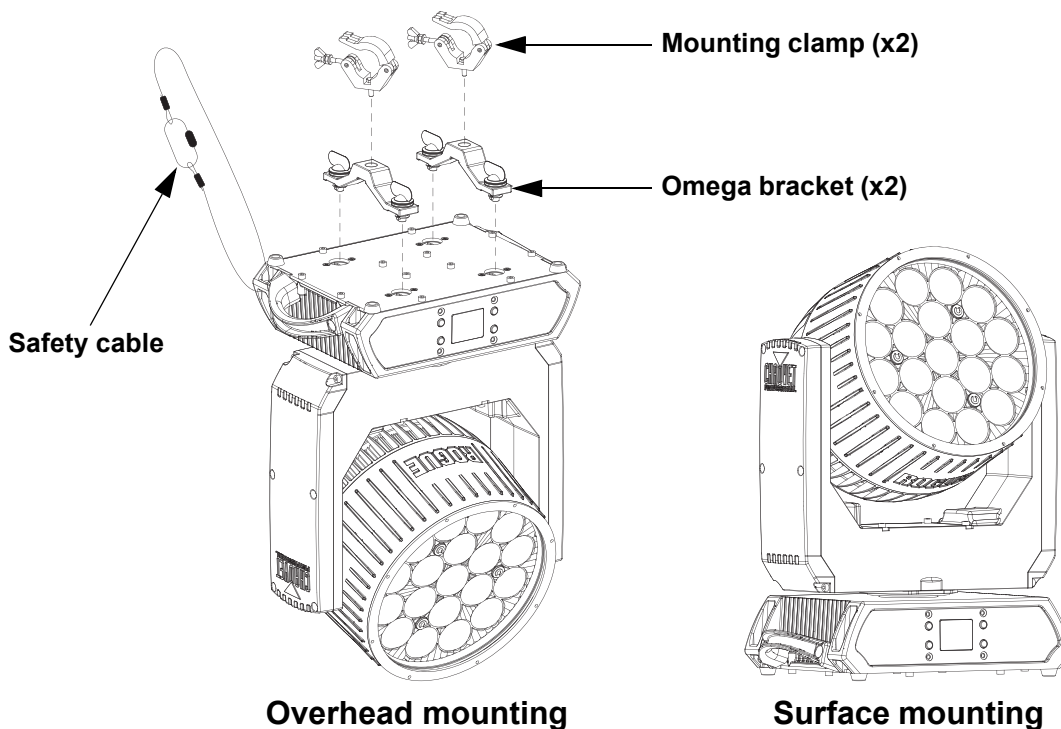

4. Operation

Control Panel Description

Button	Function
<MENU>	Exits from the current menu or function
<ENTER>	Enables the currently displayed menu or sets the selected value into the selected function
<UP>	Navigates upwards through the menu list or increases the value when in a function
<DOWN>	Navigates downwards through the menu list or decreases the value when in a function

Menu Map

Refer to the Rogue Outcast 2X Wash product page on www.chauvetprofessional.com for the latest menu map.

Main Level	Programming Levels		Description
Address	001–512		Sets the starting address
DMX	56CH	(Advanced Modes)	Selects the DMX personality
	54CH		
	33CH		
	22CH	(Basic Modes)	
	17CH		
	15CH		
	54MS	(MS Modes)	
	33MS		
Auto Test			Auto test all functions
Run Mode	Pan	0–255	Manually control and test all settings through the control panel
	Tilt		
	Dimmer		
	Shutter		
	Red1		
	Green1		
	Blue1		
	White1		
	Red2		
	Green2		
	Blue2		
	White2		
	Red3		
	Green3		
	Blue3		
	White3		
	Red4		
	Green4		
	Blue4		
	White4		
	Red5		
	Green5		
	Blue5		
	White5		
Zoom			

Main Level	Programming Levels		Description
Setup	Pan Reverse	OFF	Normal pan
		ON	Reversed pan
	Tilt Reverse	OFF	Normal tilt
		ON	Reversed tilt
	Pan Angle	540	540° pan range
		360	360° pan range
		180	180° pan range
	Tilt Angle	260	260° tilt range
		180	180° tilt range
		90	90° tilt range
		230	230° tilt range
	Fans	Auto	Fan speed according to product temperature
		Full	Fan speed set on high
		ECO	Quiet mode
	Display	OFF	Display turns off
		ON	Display stays on
	Screen Reverse	OFF	Normal screen display
		ON	Inverted screen display
	Dimmer Curve	Linear	Set the dimmer curve
		Square	
		I Squa	
		SCurve	
	Dimmer Speed	Smooth	Smooth dimmer speed
		Fast	Fast dimmer speed
	PWM Option	600Hz	Sets the PWM frequency
		1200Hz	
		2000Hz	
4000Hz			
15000Hz			
LED R POWER	050–100	Sets red LED power	
LED G POWER	050–100	Sets green LED power	
LED B POWER	050–100	Sets blue LED power	
LED W POWER	050–100	Sets white LED power	
White Mode	On	Calibrates white to 7500K	
	Off	Uses maximum output values	
	Custom	RED 000–255	Sets red LED maximum value
		GREEN 000–255	Sets green LED maximum value
		BLUE 000–255	Sets blue LED maximum value
WHITE 000–255		Sets white LED maximum value	
Color calibration	On	Uses factory default white setting	
	Off	Uses maximum output values	
	Custom	RED 100–255	Sets red LED maximum value
		GREEN 000–255	Sets green LED maximum value
BLUE 000–255		Sets blue LED maximum value	

Operation

Main Level	Programming Levels		Description	
Setup (cont.)	USB Update	NO	Update firmware via USB C	
		YES		
	Reset Function	Pan/Tilt	NO YES	Reset individual functions or all functions from start-up
		Zoom		
All				
Factory Settings	NO	Reset to factory default settings		
	YES			
Sys Info	Ver	V_ _ _ _ _	Shows firmware version	
	Running Mode	_ _ _	Shows current running mode	
	DMX Address	_ _ _	Shows current DMX address	
	Temperature	_ _ _	Shows the product's temperature in °C	
	Fixture Time	_ _ _ _	Shows time product has been on	
	UID	_ _ _ _ _ _	Shows product UID	
	Head Fan1-2	_ _ _ _ _	Shows speed of each fan	
	Base Fan1-2	_ _ _ _ _		

Configuration (DMX)

Use control configurations to operate the product with a DMX controller.

Control Personalities

To set the control personality:

1. Go to the **Run Mode** main level.
2. Select the **DMX** option.
3. Select the desired personality, from **56CH**, **54CH**, **33CH**, **22CH**, **17CH**, **15CH**, **54MS**, or **33MS**.



- See the [Starting Address](#) section for the highest starting address that can be selected for each personality.
- Make sure that the starting addresses on the various products do not overlap due to the new personality setting.

Starting Address

Each product will respond to a unique starting address from the controller. All products with the same starting address will respond in unison. To set the starting address:

1. Go to the **Address** main level.
2. Select the starting address (**001–512**).
 - The highest recommended starting address for **56CH** is **457**.
 - The highest recommended starting address for **54CH** is **459**.
 - The highest recommended starting address for **33CH** is **480**.
 - The highest recommended starting address for **22CH** is **491**.
 - The highest recommended starting address for **17CH** is **496**.
 - The highest recommended starting address for **15CH** is **498**.
 - The highest recommended starting address for **54MS** is **459**.
 - The highest recommended starting address for **33MS** is **480**.

Control Channel Assignments and Values

Zones for DMX Control

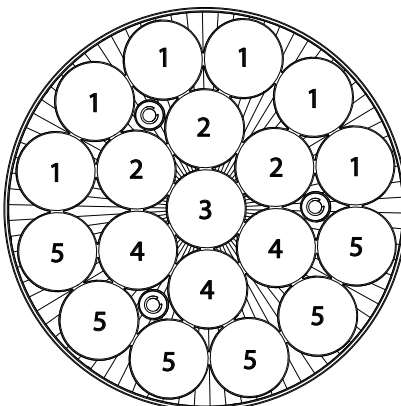

Strobe Chart

Value	Percent/Setting	Value	Percent/Setting
000 ⇔ 019	Off	145 ⇔ 149	On
020 ⇔ 024	On	150 ⇔ 164	Random strobe 0-100%, fast to slow
025 ⇔ 064	Strobe, fast to slow	165 ⇔ 169	On
065 ⇔ 069	On	170 ⇔ 184	Pulse strobe, fast to slow
070 ⇔ 084	Strobe 100-0%, fast to slow	185 ⇔ 189	On
085 ⇔ 089	On	190 ⇔ 204	Random pulse strobe, fast to slow
090 ⇔ 104	Strobe 0-100%, fast to slow	205 ⇔ 209	On
105 ⇔ 109	On	210 ⇔ 224	Strobe 100-0-100%, fast to slow
110 ⇔ 124	Random strobe, fast to slow	225 ⇔ 229	On
125 ⇔ 129	On	230 ⇔ 244	Random inverse pulse strobe, fast to slow
130 ⇔ 144	Random strobe 100-0%, fast to slow	245 ⇔ 255	On

Color Chart

Value	Percent/Setting	Value	Percent/Setting	Value	Percent/Setting
000 ⇔ 004	No function	070 ⇔ 074	Color 14	140 ⇔ 144	Color 28
005 ⇔ 009	Color 1	075 ⇔ 079	Color 15	145 ⇔ 149	Color 29
010 ⇔ 014	Color 2	080 ⇔ 084	Color 16	150 ⇔ 154	Color 30
015 ⇔ 019	Color 3	085 ⇔ 089	Color 17	155 ⇔ 159	Color 31
020 ⇔ 024	Color 4	090 ⇔ 094	Color 18	160 ⇔ 164	Color 32
025 ⇔ 029	Color 5	095 ⇔ 099	Color 19	165 ⇔ 169	Color 33
030 ⇔ 034	Color 6	100 ⇔ 104	Color 20	170 ⇔ 174	Color 34
035 ⇔ 039	Color 7	105 ⇔ 109	Color 21	175 ⇔ 179	No function
040 ⇔ 044	Color 8	110 ⇔ 114	Color 22	180 ⇔ 201	Color scroll, fast to slow
045 ⇔ 049	Color 9	115 ⇔ 119	Color 23	202 ⇔ 207	Hold
050 ⇔ 054	Color 10	120 ⇔ 124	Color 24	208 ⇔ 229	Reverse color scroll, fast to slow
055 ⇔ 059	Color 11	125 ⇔ 129	Color 25	230 ⇔ 234	No function
060 ⇔ 064	Color 12	130 ⇔ 134	Color 26	235 ⇔ 249	Color snap, fast to slow
065 ⇔ 069	Color 13	135 ⇔ 139	Color 27	250 ⇔ 255	No function

Operation

Zone Selection Chart

Value	Percent/Setting	Value	Percent/Setting	Value	Percent/Setting
000 ⇔ 007	Zone 1, 2, 3, 4, 5	088 ⇔ 095	Zone 5	176 ⇔ 183	Zone 2, 3, 4
008 ⇔ 015	Zone 1, 2, 3, 4	096 ⇔ 103	Zone 4	184 ⇔ 191	Zone 1, 2, 3
016 ⇔ 023	Zone 1, 2, 3	104 ⇔ 111	Zone 3	192 ⇔ 199	Zone 1, 2, 5
024 ⇔ 031	Zone 1, 2	112 ⇔ 119	Zone 2	200 ⇔ 207	Zone 1, 4, 5
032 ⇔ 039	Zone 1	120 ⇔ 127	Zone 1	208 ⇔ 215	Zone 2, 3, 4, 5
040 ⇔ 047	No zones	128 ⇔ 135	Zone 4, 5	216 ⇔ 223	Zone 1, 2, 3, 4
048 ⇔ 055	Zone 5	136 ⇔ 143	Zone 3, 4	224 ⇔ 231	Zone 1, 2, 3, 5
056 ⇔ 063	Zone 4, 5	144 ⇔ 151	Zone 2, 3	232 ⇔ 239	Zone 1, 2, 4, 5
064 ⇔ 071	Zone 3, 4, 5	152 ⇔ 159	Zone 1, 2	240 ⇔ 247	Zone 1, 3, 4, 5
072 ⇔ 079	Zone 2, 3, 4, 5	160 ⇔ 167	Zone 1, 5	248 ⇔ 255	Zone 1, 2, 3, 4, 5
080 ⇔ 087	Zone 1, 2, 3, 4, 5	168 ⇔ 175	Zone 3, 4, 5		

Programs Chart

Value	Percent/Setting	Value	Percent/Setting	Value	Percent/Setting
000 ⇔ 015	No function				
016 ⇔ 020	Zone program 1	096 ⇔ 100	Zone program 17	176 ⇔ 180	Color program 9
021 ⇔ 025	Zone program 2	101 ⇔ 105	Zone program 18	181 ⇔ 185	Color program 10
026 ⇔ 030	Zone program 3	106 ⇔ 110	Zone program 19	186 ⇔ 190	Color program 11
031 ⇔ 035	Zone program 4	111 ⇔ 115	Zone program 20	191 ⇔ 195	Color program 12
036 ⇔ 040	Zone program 5	116 ⇔ 120	Zone program 21	196 ⇔ 200	Color program 13
041 ⇔ 045	Zone program 6	121 ⇔ 125	Zone program 22	201 ⇔ 205	Color program 14
046 ⇔ 050	Zone program 7	126 ⇔ 130	Zone program 23	206 ⇔ 210	Color program 15
051 ⇔ 055	Zone program 8	131 ⇔ 135	Zone program 24	211 ⇔ 215	Color program 16
056 ⇔ 060	Zone program 9	136 ⇔ 140	Color program 1	216 ⇔ 220	Color program 17
061 ⇔ 065	Zone program 10	141 ⇔ 145	Color program 2	221 ⇔ 225	Color program 18
066 ⇔ 070	Zone program 11	146 ⇔ 150	Color program 3	226 ⇔ 230	Color program 19
071 ⇔ 075	Zone program 12	151 ⇔ 155	Color program 4	231 ⇔ 235	Color program 20
076 ⇔ 080	Zone program 13	156 ⇔ 160	Color program 5	236 ⇔ 240	Color program 21
081 ⇔ 085	Zone program 14	161 ⇔ 165	Color program 6	241 ⇔ 245	Color program 22
086 ⇔ 090	Zone program 15	166 ⇔ 170	Color program 7	246 ⇔ 250	Color program 23
091 ⇔ 095	Zone program 16	171 ⇔ 175	Color program 8	251 ⇔ 255	Color program 24

Control Chart

Value	Percent/Setting	Value	Percent/Setting	Value	Percent/Setting
000 ⇔ 009	No function	110 ⇔ 114	Tilt range 90°	160 ⇔ 164	S-curve dimmer curve
010 ⇔ 014	Blackout on pan/tilt	115 ⇔ 119	Tilt range 230°	165 ⇔ 169	White mode
015 ⇔ 049	Reserved for future use	120 ⇔ 124	Fan mode ECO	170 ⇔ 174	Full mode
050 ⇔ 054	Reset pan	125 ⇔ 129	Fan mode Full	175 ⇔ 179	Color calibration off when single color
055 ⇔ 059	Reset tilt	130 ⇔ 134	Fan mode Auto	180 ⇔ 184	Color calibration on when single color
060 ⇔ 064	Reset zoom	135 ⇔ 139	Fast dimmer	185 ⇔ 239	No function
065 ⇔ 069	Reserved for future use	140 ⇔ 144	Smooth dimmer	240 ⇔ 247	Color calibration on
070 ⇔ 074	Reset all	145 ⇔ 149	Linear dimmer curve	248 ⇔ 255	Color calibration off
075 ⇔ 099	Reserved for future use	150 ⇔ 154	Square dimmer curve		
100 ⇔ 104	Tilt range 260°	155 ⇔ 159	Inverse square dimmer curve		
105 ⇔ 109	Tilt range 180°				

Advanced Modes

33CH	54CH	56CH	Function	Value	Percent/Setting
1	1	1	Pan	000 ⇄ 255	0–100%
2	2	2	Fine pan	000 ⇄ 255	Fine control (16-bit)
3	3	3	Tilt	000 ⇄ 255	0–100%
4	4	4	Fine tilt	000 ⇄ 255	Fine control (16-bit)
5	5	5	Pan/tilt speed	000 ⇄ 255	Fast to slow
6	6	6	Dimmer	000 ⇄ 255	0–100%
–	7	7	Fine dimmer	000 ⇄ 255	Fine control (16-bit)
7	8	8	Strobe	000 ⇄ 255	See Strobe Chart
8	9	9	Red 1	000 ⇄ 255	0–100%
–	10	10	Fine red 1	000 ⇄ 255	Fine control (16-bit)
9	11	11	Green 1	000 ⇄ 255	0–100%
–	12	12	Fine green 1	000 ⇄ 255	Fine control (16-bit)
10	13	13	Blue 1	000 ⇄ 255	0–100%
–	14	14	Fine blue 1	000 ⇄ 255	Fine control (16-bit)
11	15	15	White 1	000 ⇄ 255	0–100%
–	16	16	Fine white 1	000 ⇄ 255	Fine control (16-bit)
12	17	17	Red 2	000 ⇄ 255	0–100%
–	18	18	Fine red 2	000 ⇄ 255	Fine control (16-bit)
13	19	19	Green 2	000 ⇄ 255	0–100%
–	20	20	Fine green 2	000 ⇄ 255	Fine control (16-bit)
14	21	21	Blue 2	000 ⇄ 255	0–100%
–	22	22	Fine blue 2	000 ⇄ 255	Fine control (16-bit)
15	23	23	White 2	000 ⇄ 255	0–100%
–	24	24	Fine white 2	000 ⇄ 255	Fine control (16-bit)
16	25	25	Red 3	000 ⇄ 255	0–100%
–	26	26	Fine red 3	000 ⇄ 255	Fine control (16-bit)
17	27	27	Green 3	000 ⇄ 255	0–100%
–	28	28	Fine green 3	000 ⇄ 255	Fine control (16-bit)
18	29	29	Blue 3	000 ⇄ 255	0–100%
–	30	30	Fine blue 3	000 ⇄ 255	Fine control (16-bit)
19	31	31	White 3	000 ⇄ 255	0–100%
–	32	32	Fine white 3	000 ⇄ 255	Fine control (16-bit)
20	33	33	Red 4	000 ⇄ 255	0–100%
–	34	34	Fine red 4	000 ⇄ 255	Fine control (16-bit)
21	35	35	Green 4	000 ⇄ 255	0–100%
–	36	36	Fine green 4	000 ⇄ 255	Fine control (16-bit)
22	37	37	Blue 4	000 ⇄ 255	0–100%
–	38	38	Fine blue 4	000 ⇄ 255	Fine control (16-bit)
23	39	39	White 4	000 ⇄ 255	0–100%
–	40	40	Fine white 4	000 ⇄ 255	Fine control (16-bit)
24	41	41	Red 5	000 ⇄ 255	0–100%
–	42	42	Fine red 5	000 ⇄ 255	Fine control (16-bit)
25	43	43	Green 5	000 ⇄ 255	0–100%
–	44	44	Fine green 5	000 ⇄ 255	Fine control (16-bit)
26	45	45	Blue 5	000 ⇄ 255	0–100%
–	46	46	Fine blue 5	000 ⇄ 255	Fine control (16-bit)

Operation

33CH	54CH	56CH	Function	Value	Percent/Setting
27	47	47	White 5	000 ⇄ 255	0–100%
–	48	48	Fine white 5	000 ⇄ 255	Fine control (16-bit)
28	49	49	Color	000 ⇄ 255	See Color Chart
29	50	50	Zone Selection	000 ⇄ 255	See Zone Selection Chart
30	51	51	Programs	000 ⇄ 255	See Programs Chart
31	52	52	Program Speed	000 ⇄ 255	0–100%
–	–	53	Movement macros	000 ⇄ 007 008 ⇄ 023 024 ⇄ 039 040 ⇄ 055 056 ⇄ 071 072 ⇄ 087 088 ⇄ 103 104 ⇄ 119 120 ⇄ 135 136 ⇄ 151 152 ⇄ 167 168 ⇄ 183 184 ⇄ 199 200 ⇄ 215 216 ⇄ 231 232 ⇄ 247 248 ⇄ 255	No function Movement macro 1 Movement macro 2 Movement macro 3 Movement macro 4 Movement macro 5 Movement macro 6 Movement macro 7 Movement macro 8 Movement macro 9 Movement macro 10 Movement macro 11 Movement macro 12 Movement macro 13 Movement macro 14 Movement macro 15 Movement macro 16
–	–	54	Movement macro speed	000 ⇄ 255	Fast to slow
32	53	55	Zoom	000 ⇄ 255	0–100%
33	54	56	Control	000 ⇄ 255	See Control Chart

Basic Modes

15CH	17CH	22CH	Function	Value	Percent/Setting
1	1	1	Pan	000 ⇄ 255	0–100%
2	2	2	Fine pan	000 ⇄ 255	Fine control (16-bit)
3	3	3	Tilt	000 ⇄ 255	0–100%
4	4	4	Fine tilt	000 ⇄ 255	Fine control (16-bit)
5	5	5	Pan/tilt speed	000 ⇄ 255	Fast to slow
6	6	6	Dimmer	000 ⇄ 255	0–100%
7	–	7	Fine dimmer	000 ⇄ 255	Fine control (16-bit)
8	7	8	Strobe	000 ⇄ 255	See Strobe Chart
9	8	9	Red	000 ⇄ 255	0–100%
–	–	10	Fine red	000 ⇄ 255	Fine control (16-bit)
10	9	11	Green	000 ⇄ 255	0–100%
–	–	12	Fine green	000 ⇄ 255	Fine control (16-bit)
11	10	13	Blue	000 ⇄ 255	0–100%
–	–	14	Fine blue	000 ⇄ 255	Fine control (16-bit)
12	11	15	White	000 ⇄ 255	0–100%
–	–	16	Fine white	000 ⇄ 255	Fine control (16-bit)
13	12	17	Color	000 ⇄ 255	See Color Chart
–	13	18	Zone Selection	000 ⇄ 255	See Zone Selection Chart

15CH	17CH	22CH	Function	Value	Percent/Setting
–	14	19	Programs	000 ⇄ 255	See Programs Chart
–	15	20	Program Speed	000 ⇄ 255	0–100%
14	16	21	Zoom	000 ⇄ 255	0–100%
15	17	22	Control	000 ⇄ 255	See Control Chart

MS Modes

33MS	54MS	Function	Value	Percent/Setting
1	1	Pan	000 ⇄ 255	0–100%
2	2	Fine pan	000 ⇄ 255	Fine control (16-bit)
3	3	Tilt	000 ⇄ 255	0–100%
4	4	Fine tilt	000 ⇄ 255	Fine control (16-bit)
5	5	Pan/tilt speed	000 ⇄ 255	Fast to slow
6	6	Dimmer	000 ⇄ 255	0–100%
–	7	Fine dimmer	000 ⇄ 255	Fine control (16-bit)
7	8	Strobe	000 ⇄ 255	See Strobe Chart
8	9	Color	000 ⇄ 255	See Color Chart
9	10	Zone Selection	000 ⇄ 255	See Zone Selection Chart
10	11	Programs	000 ⇄ 255	See Programs Chart
11	12	Program Speed	000 ⇄ 255	0–100%
12	13	Zoom	000 ⇄ 255	0–100%
13	14	Control	000 ⇄ 255	See Control Chart
14	15	Red 1	000 ⇄ 255	0–100%
–	16	Fine red 1	000 ⇄ 255	Fine control (16-bit)
15	17	Green 1	000 ⇄ 255	0–100%
–	18	Fine green 1	000 ⇄ 255	Fine control (16-bit)
16	19	Blue 1	000 ⇄ 255	0–100%
–	20	Fine blue 1	000 ⇄ 255	Fine control (16-bit)
17	21	White 1	000 ⇄ 255	0–100%
–	22	Fine white 1	000 ⇄ 255	Fine control (16-bit)
18	23	Red 2	000 ⇄ 255	0–100%
–	24	Fine red 2	000 ⇄ 255	Fine control (16-bit)
19	25	Green 2	000 ⇄ 255	0–100%
–	26	Fine green 2	000 ⇄ 255	Fine control (16-bit)
20	27	Blue 2	000 ⇄ 255	0–100%
–	28	Fine blue 2	000 ⇄ 255	Fine control (16-bit)
21	29	White 2	000 ⇄ 255	0–100%
–	30	Fine white 2	000 ⇄ 255	Fine control (16-bit)
22	31	Red 3	000 ⇄ 255	0–100%
–	32	Fine red 3	000 ⇄ 255	Fine control (16-bit)
23	33	Green 3	000 ⇄ 255	0–100%
–	34	Fine green 3	000 ⇄ 255	Fine control (16-bit)
24	35	Blue 3	000 ⇄ 255	0–100%
–	36	Fine blue 3	000 ⇄ 255	Fine control (16-bit)
25	37	White 3	000 ⇄ 255	0–100%
–	38	Fine white 3	000 ⇄ 255	Fine control (16-bit)
26	39	Red 4	000 ⇄ 255	0–100%
–	40	Fine red 4	000 ⇄ 255	Fine control (16-bit)

Operation

33MS	54MS	Function	Value	Percent/Setting
27	41	Green 4	000 ⇔ 255	0–100%
–	42	Fine green 4	000 ⇔ 255	Fine control (16-bit)
28	43	Blue 4	000 ⇔ 255	0–100%
–	44	Fine blue 4	000 ⇔ 255	Fine control (16-bit)
29	45	White 4	000 ⇔ 255	0–100%
–	46	Fine white 4	000 ⇔ 255	Fine control (16-bit)
30	47	Red 5	000 ⇔ 255	0–100%
–	48	Fine red 5	000 ⇔ 255	Fine control (16-bit)
31	49	Green 5	000 ⇔ 255	0–100%
–	50	Fine green 5	000 ⇔ 255	Fine control (16-bit)
32	51	Blue 5	000 ⇔ 255	0–100%
–	52	Fine blue 5	000 ⇔ 255	Fine control (16-bit)
33	53	White 5	000 ⇔ 255	0–100%
–	54	Fine white 5	000 ⇔ 255	Fine control (16-bit)

Configuration (Settings)

Pan Reverse

To set the orientation of the pan:

1. Go to the **Setup** main level.
2. Select the **Pan Reverse** option.
3. Select from **OFF** (normal pan motion), or **ON** (reversed pan motion).

Tilt Reverse

To set the orientation of the tilt:

1. Go to the **Setup** main level.
2. Select the **Tilt Reverse** option.
3. Select from **OFF** (normal tilt motion), or **ON** (reversed tilt motion).

Pan Angle

To set the maximum angle of the pan:

1. Go to the **Setup** main level.
2. Select the **Pan Angle** option.
3. Select from **540** (540°), **360** (360°), or **180** (180°).

Tilt Angle

To set the maximum angle of the tilt:

1. Go to the **Setup** main level.
2. Select the **Tilt Angle** option.
3. Select from **260** (260°), **180** (180°), or **90** (90°).

Fan Mode

To set the fan speed mode:

1. Go to the **Settings** main level.
2. Select the **Fans** option.
3. Select the fan mode, from **Auto** (fan speed adjusts to product temperature), **Full** (fan speed at maximum), or **ECO** (quiet mode).

Display Backlight Timer

To set whether an inactive display will turn off:

1. Go to the **Setup** main level.
2. Select the **Display** option.
3. Select the length of the backlight timer, from **OFF** (will turn off) or **ON** (always on).

Screen Reverse

To set the orientation of the display:

1. Go to the **Setup** main level.
2. Select the **Screen Rev** option.
3. Select from **OFF** (right-side up) or **ON** (upside-down).

Dimmer Curve

To set the dimmer curve:

1. Go to the **Setup** main level.
2. Select the **Dimmer Curve** option.
3. Select the dimmer curve, from **Linear**, **Square**, **I Squa**, or **SCurve**.

Dimmer Speed

To set the dimmer speed:

1. Go to the **Setup** main level.
2. Select the **Dimmer Speed** option.
3. Select the dimmer speed, from **Smooth** or **Fast**.

Pulse Width Modulation

To adjust the frequency of the pulse width modulation:

1. Go to the **Setup** main level.
2. Select the **PWM Option** option.
3. Select the frequency, from **600Hz**, **1200Hz**, **2000Hz**, **4000Hz**, **6000Hz**, or **15000Hz**.

LED Power

To set the power of each LED color:

1. Go to the **Setup** main level.
2. Select from the **LED R POWER** (red), **LED G POWER** (green), **LED B POWER** (blue), or **LED W POWER** (white) options.
3. Set the selected LED power from **050–100**.

White Mode

To turn the White Mode on or off, or edit the balance of the White Mode:

1. Go to the **Setup** main level.
2. Select the **White Mode** option.
3. Select **On** (to calibrate the color temperature to 7500K), **Off** (to sets all colors to maximum output), or **Custom** (to customize the White Mode).
4. If **Custom** was selected, then select which color to edit, from **RED**, **GREEN**, **BLUE**, or **WHITE**.
5. Increase or decrease the maximum output level of the selected color, from **000–255**.

Color Calibration

To alter the color calibration settings:

1. Go to the **Setup** main level.
2. Select the **Color Calibration** option.
3. Select the calibration mode, from **On** (Uses factory default settings), **Off** (Sets all colors to maximum output), or **Custom** (To set a custom white balance).
4. If **Custom** was selected, then select which color to edit, from **RED**, **GREEN**, or **BLUE**.
5. Increase or decrease the maximum output level of the selected color, from **100–255**.

USB Update

To enable or disable software update using USB:

1. Go to the **Setup** main level.
2. Select the **USB Update** option.
3. Select **NO** (disables software update through USB) or **YES** (enables software update through USB).



See the [USB Software Update](#) section for the detailed instructions on how to update the Rogue Outcast 2X Wash software using a USB C connection.

Operation

Reset Function

To reset specific functions or the entire product:

1. Go to the **Setup** main level.
2. Select the **Reset Function** option.
3. Select the functions to reset, from **Pan/Tilt, Zoom, or All**.
4. Select **NO** (to cancel) or **YES** (to reset the selected functions).

Factory Reset

To reset the product to factory settings:

1. Go to the **Setup** main level.
2. Select the **Factory Reset** option.
3. Select **NO** (to cancel) or **YES** (to reset the product configuration).

Test Mode

Auto Test

To have the Rogue Outcast 2X Wash automatically test all functions one after the other:

1. Go to the **Run Mode** main level.
2. Select the **Auto Test** option.

Manual Test

To manually test an individual function of the Rogue Outcast 2X Wash:

1. Go to the **Run Mode** main level.
2. Select the **Manual Test** option.
3. Select a function to test, from **Pan, Tilt, Dimmer, Shutter, Red 1, Green 1, Blue 1, White 1, Red 2, Green 2, Blue 2, White2, Red 3, Green 3, Blue 3, White3, Red 4, Green 4, Blue 4, White4, Red 5, Green 5, Blue 5, White5, or Zoom**.
4. Increase or decrease the value of the selected function from **000–255** to test it.

System Information

The information section of the menu displays statistics and the current status of the product's various functions. To view this information:

1. Go to the **Sys Info** main level.
2. Use **<UP>** and **<DOWN>** to view all information.

Offset Mode (Zero Adjust)

The Offset mode provides fine adjustments for the home position of the pan, tilt, and zoom movements. To adjust these options:

1. From the main level screen, press and hold **<MENU>** until the passcode screen appears.
2. Use **<UP>** (increase value) and **<DOWN>** (next value) to enter the passcode: **2323** and press **<ENTER>**.
3. Select the "zero" position to adjust, from **PAN, TILT, ZOOM, RDM4, RDM5, or RDM6**.
4. Adjust the "zero" position for the selected function from **000–255**.

5. Maintenance

Product Maintenance

Dust build-up reduces light output performance and can cause overheating. This can lead to reduction of the light source's life and/or mechanical wear. To maintain optimum performance and minimize wear, clean the lighting products at least twice a month. However, be aware that usage and environmental conditions could be contributing factors to increase the cleaning frequency.

To clean the product, follow the instructions below:

1. Unplug the product from power.
2. Wait until the product is at room temperature.
3. Use a vacuum (or dry compressed air) and a soft brush to remove dust collected on the external surface/vents.
4. Clean all transparent surfaces with a mild soap solution, ammonia-free glass cleaner, or isopropyl alcohol.
5. Apply the solution directly to a soft, lint free cotton cloth or a lens cleaning tissue.
6. Softly drag any dirt or grime to the outside of the transparent surface.
7. Gently polish the transparent surfaces until they are free of haze and lint.



Always dry the transparent surfaces carefully after cleaning them.



Do not spin the cooling fans with compressed air. Damage may result.

Torque Measurements

To maintain the IP rating when reassembling the product, use the given torque measurements for each of the following screws and bolts:

- Screws inside feet: 9.17 Kgf.cm, 7.96 lgb.in
- Base screws around outside (not the feet): 15.29 Kgf.cm, 13.27 lgb.in
- Omega bracket holder: 12.2 Kgf.cm, 10.6 lgb.in
- Screws around power and data ports: 3.5 Kgf.cm, 3 lgb.in
- Fuse: 7.13 Kgf.cm, 6.19 lgb.in
- Center of yoke plate: 15.29 Kgf.cm, 13.27 lgb.in
- Arm cover screws: 18.35 Kgf.cm, 15.93 lgb.in
- Allen Key screws next to front lens: 25.5 Kgf.cm, 22.1 lgb.in
- Allen Key screws around head fan: 15.29 Kgf.cm, 13.27 lgb.in
- Allen Key screws head covers: 10.19 Kgf.cm, 8.85 lgb.in

Vacuum Test Measurements

To ensure that the product has been reassembled correctly, use the IP Tester from Chauvet Professional to check the following data has the given measurements for the given method:

- Method: Positive
- Test Pressure (kPa): 2.18
- Test Duration (seconds): 60
- PASS State leak pressure (kPa): <0.02

6. Technical Specifications

Dimensions and Weight

Length	Width	Height	Weight
11.92 in (303 mm)	8.58 in (218 mm)	14.1 in (361 mm)	23.4 lb (10.6 kg)

Note: Dimensions in inches are rounded.

Power

Power Supply Type	Range	Voltage Selection
Switching (internal)	100 to 240 VAC, 50/60 Hz	Auto-ranging

Parameter	100 V, 60 Hz	120 V, 60 Hz	208 V, 60 Hz	230 V, 50 Hz	240 V, 50 Hz
Consumption	295 W	291 W	284 W	282 W	281 W
Operating Current	2.98 A	2.47 A	1.41 A	1.28 A	1.23 A
Power linking (products)	4 products	5 products	9 products	10 products	11 products
Fuse/Breaker	8 A, 250 V	8 A, 250 V	8 A, 250 V	8 A, 250 V	8 A, 250 V

Power I/O	U.S./Worldwide	UK/Europe
Power Input Connector	Seetronic Powerkon A	Seetronic Powerkon A
Power Output Connector	Seetronic Powerkon A	Seetronic Powerkon A
Power Cable plug	Bare end	Bare end

Light Source

Type	Color	Quantity	Power	Current	Lifespan
LED	Quad-color RGBW	19	25 W	1.5 A	50,000 hours

Photometrics

Beam Angle	Field Angle	Cutoff Angle	Zoom Angle
8° to 36.1°	11.8° to 53°	17.5° to 66.1°	8° to 66.1°

Illuminance @ 5 m (11.8°)	Illuminance @ 5 m (53°)
8,713 lux	694 lux

Thermal

Maximum External Temperature	Cooling System
113 °F (45 °C)	Fan-assisted Convection

DMX

I/O Connector	Channel Range
5-pin XLR	15, 17, 22, 33, 54, or 56

Ordering

Product Name	Item Name	Item Code	UPC Number
Rogue Outcast 2X Wash	ROGUEOUTCAST2XWASH	08011935	781462222833



Contact Us

General Information	Technical Support
Chauvet World Headquarters	
Address: 3360 Davie Rd. Davie, FL 33314 Voice: (954) 577-4455 Fax: (954) 929-5560 Toll Free: (800) 762-1084	Voice: (844) 393-7575 Fax: (954) 756-8015 Email: chauvetcs@chauvetlighting.com Website: www.chauvetdj.com
Chauvet U.K.	
Address: Unit 1C Brookhill Road Industrial Estate Pinxton, Nottingham, UK NG16 6NT Voice: +44 (0) 1773 511115 Fax: +44 (0) 1773 511110	Email: UKtech@chauvetlighting.eu Website: www.chauvetdj.eu
Chauvet Benelux	
Address: Stokstraat 18 9770 Kruishoutem Belgium Voice: +32 9 388 93 97	Email: BNLtech@chauvetlighting.eu Website: www.chauvetdj.eu
Chauvet France	
Address: 3, Rue Ampère 91380 Chilly-Mazarin France Voice: +33 1 78 85 33 59	Email: FRtech@chauvetlighting.fr Website: www.chauvetdj.eu
Chauvet Germany	
Address: Bruno-Bürgel-Str. 11 28759 Bremen Germany Voice: +49 421 62 60 20	Email: DEtech@chauvetlighting.de Website: www.chauvetdj.eu
Chauvet Mexico	
Address: Av. de las Partidas 34 - 3B (Entrance by Calle 2) Zona Industrial Lerma Lerma, Edo. de México, CP 52000 Voice: +52 (728) 690-2010	Email: servicio@chauvet.com.mx Website: www.chauvetdj.mx

Warranty & Returns

For warranty registration and complete terms and conditions, please visit the Chauvet website.

For customers in the United States and Mexico: www.chauvetlighting.com/warranty-registration.

For customers in the United Kingdom, Republic of Ireland, Belgium, the Netherlands, Luxembourg, France, and Germany: www.chauvetlighting.eu/warranty-registration.